

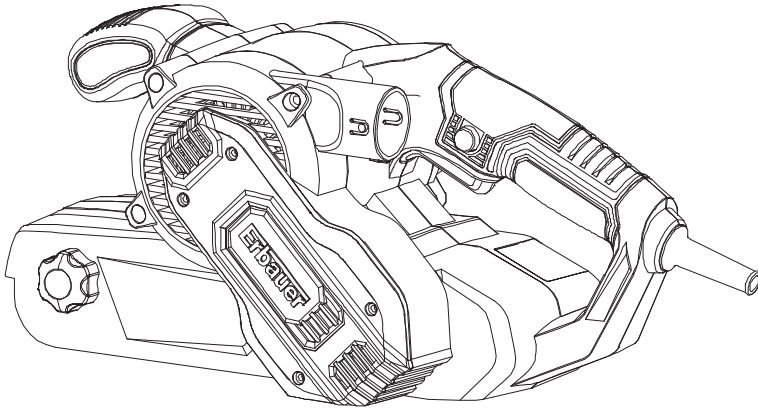

Erbauer









EAN: 3663602796565

EBS950

ORIGINAL INSTRUCTIONS



| | | |
|---|---------------------------|----|
|  | Safety instructions | 6 |
|  | Product description | 17 |
|  | Assembly | 19 |
|  | Use | 22 |
|  | Care & maintenance | 24 |
|  | Guarantee | 27 |
|  | Declaration of conformity | 28 |



WARNING! Please read all safety warnings carefully and be sure that they are fully understood before handling the tool.

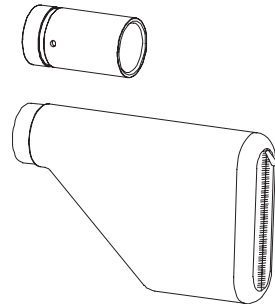
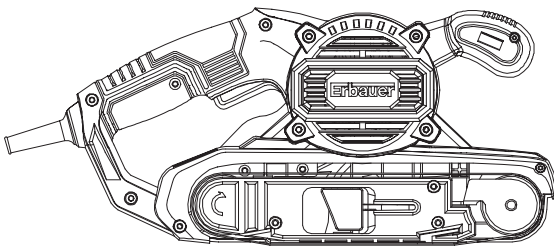



Product description

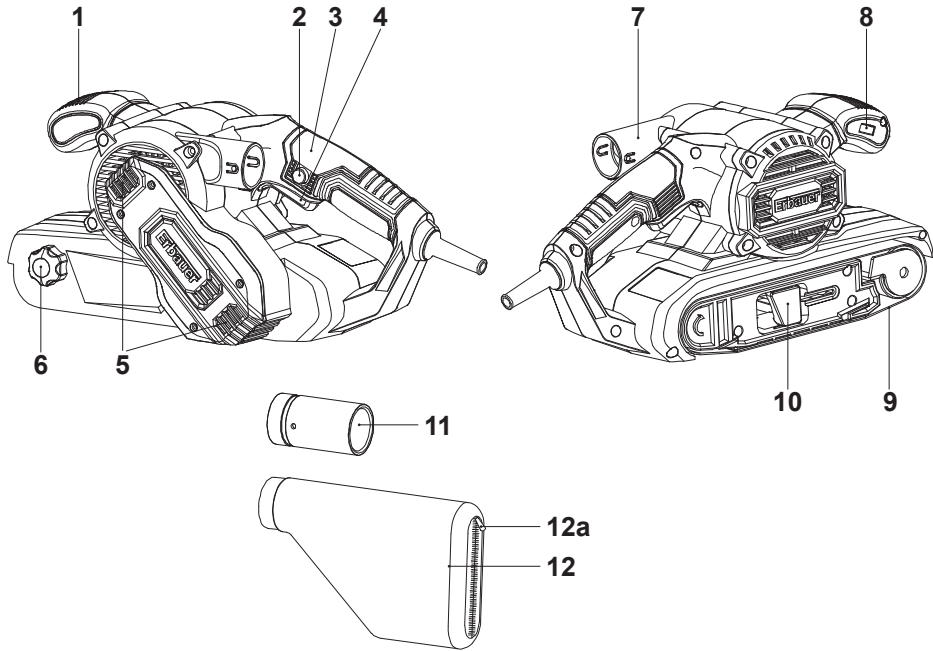

A

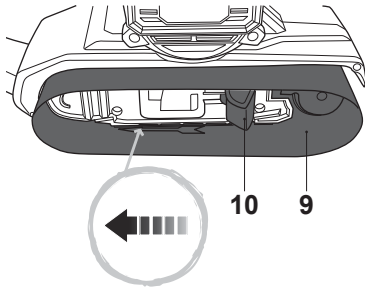

B

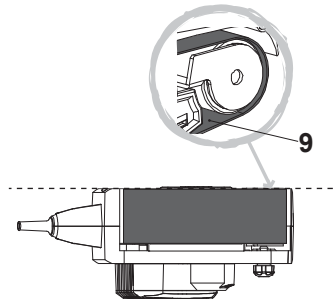



C

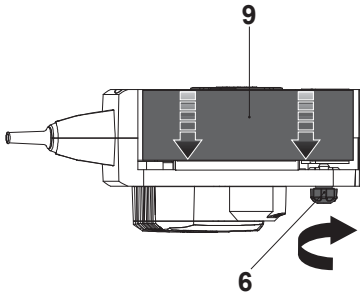

D

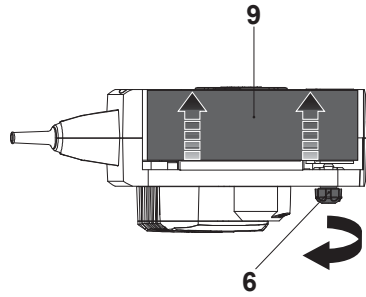

E

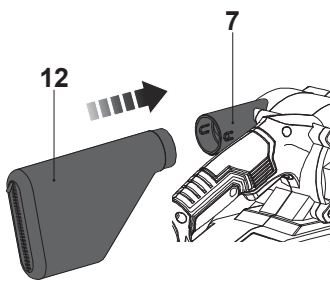

F

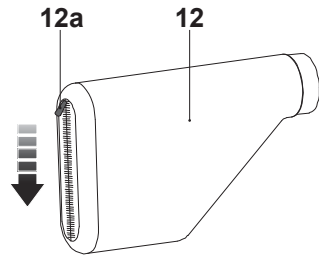

G

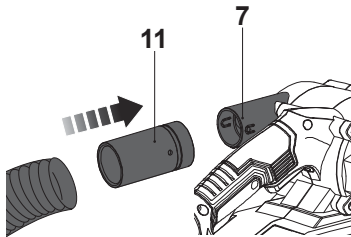

H

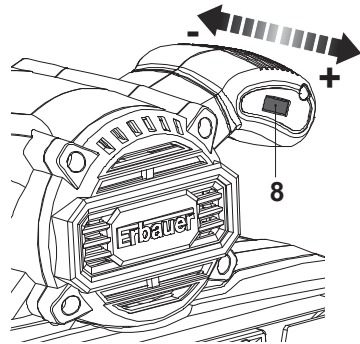

I

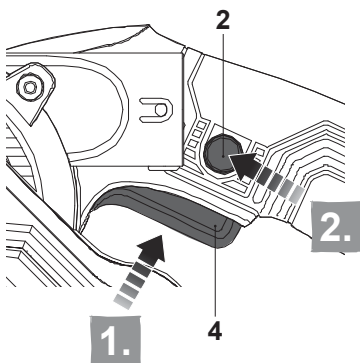



Safety instructions

GENERAL POWER TOOL SAFETY WARNING



WARNING! Read all safety warnings, instructions, illustrations and specifications provided with this power tool. *Failure to follow all instructions listed below may result in electric shock, fire and/or serious injury.*

Save all warnings and instructions for future reference.

The term “power tool” in the warnings refers to your mains-operated (corded) power tool or battery-operated (cordless) power tool.

1) WORK AREA SAFETY

- a) **Keep work area clean and well lit.** *Cluttered or dark areas invite accidents.*
- b) **Do not operate power tools in explosive atmospheres, such as in the presence of flammable liquids, gases or dust.** *Power tools create sparks which may ignite the dust or fumes.*
- c) **Keep children and bystanders away while operating a power tool.** *Distractions can cause you to lose control.*

2) ELECTRICAL SAFETY

- a) **Power tool plugs must match the outlet. Never modify the plug in any way. Do not use any adapter plugs with earthed (grounded) power tools.** *Unmodified plugs and matching outlets will reduce risk of electric shock.*



- b) **Avoid body contact with earthed or grounded surfaces, such as pipes, radiators, ranges and refrigerators.** *There is an increased risk of electric shock if your body is earthed or grounded.*
- c) **Do not expose power tools to rain or wet conditions.** *Water entering a power tool will increase the risk of electric shock.*
- d) **Do not abuse the cord. Never use the cord for carrying, pulling or unplugging the power tool. Keep cord away from heat, oil, sharp edges or moving parts.** *Damaged or entangled cords increase the risk of electric shock.*
- e) **When operating a power tool outdoors, use an extension cord suitable for outdoor use.** *Use of a cord suitable for outdoor use reduces the risk of electric shock.*
- f) **If operating a power tool in a damp location is unavoidable, use a residual current device (RCD) protected supply.** *Use of an RCD reduces the risk of electric shock.*

3) PERSONAL SAFETY

- a) **Stay alert, watch what you are doing and use common sense when operating a power tool. Do not use a power tool while you are tired or under the influence of drugs, alcohol or medication.** *A moment of inattention while operating power tools may result in serious personal injury.*
- b) **Use personal protective equipment. Always wear eye protection.** *Protective equipment such as a dust mask, non-skid safety shoes, hard hat, or hearing protection used for appropriate conditions will reduce personal injuries.*

- c) **Prevent unintentional starting. Ensure the switch is in the off-position before connecting to power source and/or battery pack, picking up or carrying the tool.** *Carrying power tools with your finger on the switch or energising power tools that have the switch on invites accidents.*
- d) **Remove any adjusting key or wrench before turning the power tool on.** *A wrench or a key left attached to a rotating part of the power tool may result in personal injury.*
- e) **Do not overreach. Keep proper footing and balance at all times.** *This enables better control of the power tool in unexpected situations.*
- f) **Dress properly. Do not wear loose clothing or jewellery. Keep your hair and clothing away from moving parts.** *Loose clothes, jewellery or long hair can be caught in moving parts.*
- g) **If devices are provided for the connection of dust extraction and collection facilities, ensure these are connected and properly used.** *Use of dust collection can reduce dust-related hazards.*
- h) **Do not let familiarity gained from frequent use of tools allow you to become complacent and ignore tool safety principles.** *A careless action can cause severe injury within a fraction of a second.*

4) POWER TOOL USE AND CARE

- a) **Do not force the power tool. Use the correct power tool for your application.** *The correct power tool will do the job better and safer at the rate for which it was designed.*
- b) **Do not use the power tool if the switch does not turn it on and off.** *Any power tool that cannot be controlled with the switch is dangerous and must be repaired.*

- c) **Disconnect the plug from the power source and/or the battery pack from the power tool before making any adjustments, changing accessories, or storing power tools.** *Such preventive safety measures reduce the risk of starting the power tool accidentally.*
- d) **Store idle power tools out of the reach of children and do not allow persons unfamiliar with the power tool or these instructions to operate the power tool.** *Power tools are dangerous in the hands of untrained users.*
- e) **Maintain power tools. Check for misalignment or binding of moving parts, breakage of parts and any other condition that may affect the power tool's operation. If damaged, have the power tool repaired before use.** *Many accidents are caused by poorly maintained power tools.*
- f) **Keep cutting tools sharp and clean.** *Properly maintained cutting tools with sharp cutting edges are less likely to bind and are easier to control.*
- g) **Use the power tool, accessories and tool bits etc. in accordance with these instructions, taking into account the working conditions and the work to be performed.** *Use of the power tool for operations different from those intended could result in a hazardous situation.*
- h) **Keep handles and grasping surfaces dry, clean and free from oil and grease.** *Slippery handles and grasping surfaces do not allow for safe handling and control of the tool in unexpected situations.*

5) SERVICE

- a) **Have your power tool serviced by a qualified repair person using only identical replacement parts.** *This will ensure that the safety of the power tool is maintained.*

SAFETY WARNINGS FOR BELT SANDER

- a) **Hold the power tool by insulated gripping surfaces, because the sanding surface may contact its own cord.** *Cutting a “live” wire may make exposed metal parts of the power tool “live” and could give the operator an electric shock.*
- b) **Take special care to protect yourself and people around against dusts, including the following:**
 - *All persons entering the work area must wear an appropriate dust mask specially designed for protection against harmful / toxic dusts, in addition to using the dust extraction facility and keeping work area well ventilated.*
 - *Children and pregnant women must not enter the work area.*
 - *Do not eat, drink or smoke in the work area.*
 - *Some wood and wood type products especially MDF (Medium Density Fibreboard) can produce dust that can be hazardous to your health. We recommend the use of a dust mask with replaceable filters when using this product in addition to using the dust extraction facility.*
- c) *The power tool shall not be wet or applied in wet environment.*
- d) *The voltage of the power source must agree with the voltage specified on the rating label of the machine.*
- e) *Check the product, its power cord and plug as well as accessories for damage before each use. Do not use the product if it is damaged or shows wear.*
- f) *Double check that the accessories and attachments are properly fixed. One minute testing running in no-load condition will be helpful to identify any problems.*
- g) *Secure the workpiece. A workpiece clamped with clamping devices or in a vice is held more secure than by hand.*

- h) *Keep the handles dry to ensure safe control. Grip the product securely with two hands so you have full control at all times.*
- i) *Ensure that the air vents are always unobstructed and clear. Clean them if necessary with a soft brush. Blocked air vents may lead to overheating and damage the product.*
- j) *Switch the product off immediately if you are disturbed while working by other people entering the working area. Always let the product come to complete stop before putting it down.*
- k) *Do not overwork yourself. Take regular breaks to ensure you can concentrate on the work and have full control over the product.*
- l) *Always keep the power cord behind the power tool.*

The following information applies to professional users only but is good practice for all users:

ADDITIONAL SAFETY WARNINGS FOR CONSTRUCTION DUST

The updated Control of Substances Hazardous to Health Regulations 1st October 2012 now also targets to reduce the risks associated with silica, wood and gypsum dusts.

Construction workers are one of the at-risk groups within this because of the dust that they breathe: silica dust is not just a nuisance; it is a real risk to your lungs!

Silica is a natural mineral present in large amounts in things like sand, sandstone and granite. It is also commonly found in many construction materials such as concrete and mortar. The silica is broken into very fine dust (also known as Respirable Crystalline Silica or RCS) during many common tasks such as cutting, drilling and grinding. Breathing in very fine particles of crystalline silica can lead to the development of:

- lung cancer
- Silicosis
- Chronic obstructive pulmonary disease (COPD).

And breathing in fine particles of wood dust can lead to the development of Asthma. The risk of lung disease is linked to people who regularly breathe construction dust over a period of time, not on the odd occasion.

To protect the lung, the COSHH Regulations sets a limit on the amount of these dusts that you can breathe (called a Workplace Exposure Limit or WEL) when averaged over a normal working day. These limits are not a large amount of dust: when compared to a penny it is tiny – like a small pinch of salt:

This limit is the legal maximum; the most you can breathe after the right controls have been used.

How to reduce the amount of dust?

1. Reduce the amount of cutting by using the best sizes of building products.
2. Use a less powerful tool e.g. a block cutter instead of angle grinder.
3. Using a different method of work altogether – e.g. using a nail gun to direct fasten cable trays instead of drilling holes first.

Please always work with approved safety equipment, such as those dust masks that specially designed to filter out microscopic particles and use the dust extraction facility at all time.

For more information please see the HSE website:

<http://www.hse.gov.uk/construction> or <http://www.hse.gov.uk/pubns/cis69.pdf>



WARNING! Some dust particles created by power sanding, sawing, grinding, drill and other construction jobs contain chemicals known to cause cancer, birth defects or other reproductive harm. Some examples of these chemicals are:

- Lead from lead-based paints.
- Crystalline silica from bricks and cement and other masonry products.
- Arsenic and chromium from chemically treated timber.

Your risk from these exposures varies, depending upon how often you do this type of work. To reduce your exposure to these dusts:

- Work in a well-ventilated.
- Work with approved protective equipment, such as those dust masks that are specially designed to filter microscopic particles.



WARNING! Certain dusts, such as oak or beech dust, are considered as carcinogenic, especially in connection with wood-treatment additives (chromate, wood preservative).

Materials containing asbestos may only be worked by specialists. Use a dust extraction system suitable for the material as far as possible.

VIBRATION

The European Physical Agents (Vibration) Directive has been brought in to help reduce hand arm vibration syndrome injuries to power tool users. The directive requires power tool manufacturers and suppliers to provide indicative vibration test results to enable users to make informed decisions as to the period of time a power tool can be used safely on a daily basis and the choice of tool.

SEE TECHNICAL SPECIFICATIONS IN THE INSTRUCTION MANUAL FOR THE VIBRATION LEVELS OF YOUR TOOL.

The declared vibration emission value should be used as a minimum level and should be used with the current guidance on vibration.

Calculating the actual period of use can be difficult and the HSE website has further information.

The declared vibration total value has been measured in accordance with EN 62841-1 and EN 62841-2-4 and may be used for compare one tool with another.

The declared vibration total value may also be used in a preliminary assessment of exposure.



WARNING! The vibration emission during actual use of the power tool can differ from the declared total value depending on the ways in which the tool is used:

- How the materials are grinded, cut or drilled.
- If the tool is in good condition and well maintained.
- Use correct accessory for the tool and ensure it is sharp and in good condition.
- The tightness of the grip on the handles.
- The tool is being used as intended by its design and these instructions.

While working with this power tool, hand/arm vibrations occur. Adopt the correct working practices in order to reduce the exposure to vibration. This tool may cause hand-arm vibration syndrome if its use is not adequately managed.



WARNING! Identify safety measures to protect the operator that are based on an estimation of exposure in the actual conditions of use (taking account of all parts of the operating cycle such as the times when the tool is switched off and when it is running idle in addition to the trigger time).

Note:

- The use of other tools will reduce the users' total working period on this tool.
- Helping to minimise your vibration exposure risk. ALWAYS use sharp chisels, drills and blades.
- Maintain this tool in accordance with these instructions and keep well lubricated (where appropriate).
- Avoid using tools in temperatures of 10 °C or less. Plan your work schedule to spread any high vibration tool use across a number of days.

Health surveillance

All employees should be part of an employer's health surveillance scheme to help identify any vibration related diseases at an early stage, prevent disease progression and help employees stay in work.

VIBRATION AND NOISE REDUCTION

To reduce the impact of noise and vibration emission, limit the time of operation, use low-vibration and low-noise operating modes as well as wear personal protective equipment.

Take the following points into account to minimise the vibration and noise exposure risks:

1. Only use the product as intended by its design and these instructions.
2. Ensure that the product is in good condition and well maintained.

3. Use correct attachments for the product and ensure they are in good condition.
4. Keep tight grip on the handles/grip surface.
5. Maintain this product in accordance with these instructions and keep it well lubricated (where appropriate).
6. Plan your work schedule to spread any high vibration tool use across a longer period of time.
7. Prolonged use of the product exposes the user to vibrations that can cause a range of conditions collectively known as hand-arm vibration syndrome (HAVS) e.g. fingers going white; as well as specific diseases such as carpal tunnel syndrome. To reduce this risk when using the product, always wear protective gloves and keep your hands warm.

RESIDUAL RISKS

Even if you are operating this product in accordance with all the safety requirements, potential risks of injury and damage remain. The following dangers can arise in connection with the structure and design of this product:

1. Health defects resulting from vibration emission if the product is being used over long periods of time or not adequately managed and properly maintained.
2. Injuries and damage to property due to broken attachments or the sudden impact of hidden objects during use.
3. Danger of injury and property damage caused by flying objects or poor power tool accessories.



WARNING! This product produces an electromagnetic field during operation! This field may under some circumstances interfere with active or passive medical implants! To reduce the risk of serious or fatal injury, we recommend persons with medical implants to consult their doctor and the medical implant manufacturer before operating this product!



Product description

Part index

The index below refers to Fig. 1 on page 4.

- | | |
|---------------------------------|-------------------------------------|
| 1. Front handle | 8. Speed dial |
| 2. Lock-on button | 9. Sanding belt |
| 3. Main handle | 10. Clamping lever for sanding belt |
| 4. On/Off switch | 11. Dust extraction adapter |
| 5. Air vents | 12. Dust bag |
| 6. Adjustment knob for belt run | a. Zip fastener |
| 7. Dust extraction outlet | |

Symbols

On the product, the rating label and within these instructions you will find among others the following symbols and abbreviations. Familiarize yourself with them to reduce hazards like personal injuries and damage to property.



Always wear eye protection.



Always wear ear protection.



Wear a dust mask.



Wear protective gloves.



Note / Remark.



Caution / Warning.



To reduce the risk of injury, user must read instruction manual.



Switch the product off and disconnect it from the power supply before assembly, cleaning, adjustments, maintenance, storage and transportation.



This product is of protection class II. That means it is equipped with enhanced or double insulation.



The product complies with the applicable European directives and an evaluation method of conformity for these directives was done.



WEEE symbol. Waste electrical products should not be disposed of with household waste. Please recycle where facilities exist. Check with your Local Authority or local store for recycling advice.

yyWxx

Manufacturing date code; year of manufacturing (20yy) and week of manufacturing (Wxx)



3 metre Power Cord Length

Technical data

| | |
|---|--|
| Rated voltage, frequency | : 220-240 V~, 50 Hz |
| Rated power input | : 950 W |
| No-load belt speed | : 240 – 350 m/min |
| Sanding belt width | : 76 mm |
| Sanding belt length | : 533 mm |
| Protection class | : II  |
| Weight | : 3.4 kg |
| Sound pressure level L_{pA} | : 89.5 dB(A) |
| Sound power level L_{WA} | : 100.5 dB(A) |
| Uncertainty K_{pA}, K_{WA} | : 3 dB(A) |
| Vibration total value a_h | : 2.3 m/s ² |
| Uncertainty K | : 1.5 m/s ² |

The sound emission values have been obtained according to the noise test code given in EN 62841-1 and EN 62841-2-4. The noise for the operator may exceed 80 dB(A) and ear protection measures are necessary.

Rating label explanation

EBS950 = Model number
 E = Erbauer
 BS = Belt sander
 950 = Power (Watts)



Assembly

01

Unpacking

1. Unpack all parts and lay them on a flat, stable surface.
2. Remove all packing materials and shipping devices, if applicable.
3. Make sure the delivery contents are complete and free of any damage. If you find that parts are missing or show damage do not use the product but contact your dealer. Using an incomplete or damaged product represents a hazard to people and property.
4. Ensure that you have all the accessories and tools needed for assembly and operation. This also includes suitable personal protective equipment.



WARNING! The product must be fully assembled before operation! Do not use a product that is only partly assembled or assembled with damaged parts!



Wear protective gloves for this assembly work and always lay the product on a flat and stable surface while assembling.

Follow the assembly instructions step-by-step and use the pictures provided as a visual guide to easily assemble the product!



Do not connect the product to power supply before it is completely assembled!



WARNING! The product and the packaging are not children's toys! Children must not play with plastic bags, sheets and small parts! There is a danger of choking and suffocation!

02

Sanding belt

Choosing the right sanding belt

Sanding belts are available with different grain sizes (grit). The grain size is indicated with a number on the reverse of the sanding belt, the higher the number the finer is the grain size.

| Grain size | Class | Application |
|------------|--------|--|
| 40-60 | Coarse | Removal of paint and varnish, preparation of rough surfaces. |
| 80-120 | Medium | For face sanding and planning small irregularities. |
| 180-240 | Fine | Finishing, cleaning plaster and water stain from wood. |

Changing/Attaching: (Fig. A, B)

1. Pull the clamping lever for sanding belt (10) outward completely. The sanding belt (9) is now loose and can be removed by applying even pulling force from both sides. (Fig. A)
2. Attach a new sanding belt with even pressing force at both sides. Pay attention that the direction of the arrows on the inside of the sanding belt (9) corresponds with the rotation direction of the belt sander. The sanding belt (9) should align with the metal guiding base as shown in Fig. B.
3. Press clamping lever for sanding belt (10) back to its initial position and the sanding belt should be correctly tensioned now.

Adjustment of belt run (Fig. C, D)

After correct assembly of the sanding belt (9), the belt run should be automatically centred upon switching on and during the sanding application. If it is not centred, the belt run should be readjusted.

1. Put the machine upside down on a flat and stable work bench and switch on the machine at low speed.
2. Turn the adjustment knob for belt run (6) as instructed in Fig. C **and** D until the sanding belt (9) runs in a correct position like shown in Fig. B.

03**Dust bag**

1. Attach the dust bag (12) to the dust extraction outlet (7) (Fig. E).
2. To remove the dust bag (12), just pull it out.



WARNING! Attach the dust bag or a dust extraction device when using this product to sand wood in order to keep the working area clean! Wear a dust mask when operating this product! Dust can be harmful to health! Especially dust and chips of wood that has been treated, e.g. with a wood preservative or stain!



WARNING! Do not use dust bag or a dust extraction device when sanding metal! The hot metal particles could cause residual wood dust, the bag itself or the filter of dust extraction device to catch fire!

04**Vacuum cleaner**

Alternatively a suitable vacuum cleaner (Ø35mm port) can be connected to the dust extraction adapter (11) and then to the dust extraction outlet (7) as shown in Fig. G.



Use

Intended use

This product is intended for sanding the following materials: wood, plastic, metal, fillers as well as varnished surfaces. This product should not be used on other materials or those harmful to health. It is to be used for dry operation only without water or other cooling liquids.

Before you start

01 Protection



Controls

01 Speed dial

The proper belt speed can be pre-selected with the speed dial (8) as instructed in Fig. H. The speed can also be changed during operation.

The required belt speed depends on the material being sanded and should be determined by practical testing regarding removal efficiency and surface quality.

02 On/Off switch & Lock-on button (Fig. I)

| Mode | Action | Application |
|---------|--|---|
| Instant | Press the On/Off switch (4) | Switch on the power tool. |
| Lock-on | Press the On/Off switch (4) fully, hold it in position and press the lock-on button (2). See Fig. I. | The power tool will run continuously and be limited at a speed preselected by speed dial (8). No need to hold the switch after lock-on. |
| Off | Release the On/Off switch (4) for instant mode, or press and release the On/Off switch (4) for lock-on mode. | Switch off the power tool. |

Operation

01 General

- Only use suitable sanding belts in terms of application and size. The sanding removal rate and the surface quality are mainly determined by the selection of the sanding belt as well as by belt speed. The higher the belt speed, the more material is removed and the finer the sanded surface.
- Replace worn or damaged sanding belts immediately.
- Start with a coarse sanding belt and finish with a fine-grained one to achieve a satisfactory result.
- Do not use the same sanding belt on different materials, e. g. do not use the sanding belt that has been used for sanding metal to sand wood. Small metal particles remaining in the sanding belt will lead to scratches.
- Ensure the workpiece is free of obstacles like nails or screws before operation. Remove them if required. Where possible, secure smaller workpieces to prevent them from moving under the product.
- Hold the product with one hand on the front handle (1) and with the other hand on the main handle (3).
- Switch the product on and wait until it runs at full speed before placing it on the workpiece.
- Move the product slowly and steadily over the workpiece surface in parallel and overlapping strokes.
- Only apply the least possible pressure to keep the product flat on the workpiece. Higher pressure will not increase but lower the performance of the product, increase wear of the sanding belt and leads to uneven results.
- Work with dust extraction system particularly when sanding coats of varnish as the varnish could melt and smear the surface of the workpiece and the sanding belt.
- Empty the dust bag (12) by detaching it and opening the zip fastener (12.a) (Fig. F) when it is half full. An overfilled dust bag lowers the performance of the product.
- Keep the product moving at all times, do not stop in one position to avoid grooves.
- Lift the product from the workpiece before switching it off.

After use

- Switch the product off, wait for complete stop, disconnect it from the power supply and let it cool down.
- Check, clean and store the product as described below.



Care & maintenance



WARNING! Always switch the product off, disconnect the product from the power supply and let the product cool down before performing inspection, maintenance and cleaning work!



Only perform care and maintenance work according to these instructions! All further works must be performed by a qualified specialist!

Clean

1. Clean the product with a dry cloth. Use a brush for areas that are hard to reach.
2. In particular clean the switches and air vents after every use with a cloth and brush.
3. Remove stubborn dirt with high pressure air (max. 3 bar).
4. Check for worn or damaged parts. Replace worn parts as necessary or contact an authorised service centre for repair before using the product again.



Do not use chemical, alkaline, abrasive or other aggressive detergents or disinfectants to clean this product as they might be harmful to its surfaces.

Maintenance

Your power tool requires no additional lubrication or maintenance.

There are no user serviceable parts in your power tool.

Before and after each use, check the product and accessories (or attachments) for wear and damage. If required, exchange them for new ones as described in this instruction manual.

01 Power cord

If the replacement of the supply cord is necessary, this has to be done by the manufacturer or his agent in order to avoid a safety hazard.

02 UK plug (only for UK market)

Replacement of the plug shall always be carried out by the manufacturer of the tool or his service organization and follow the instructions below.

IMPORTANT: The wires in the mains lead are coloured in accordance with the following code:

Blue – Neutral Brown – Live

As the colours of the wire in the mains lead of this product may not correspond with the coloured marking identifying the terminals in your plug, proceed as follows. The wire, which is coloured blue, must be connected to the terminal, which is marked with N or coloured black. The wire, which is coloured brown, must be connected to the terminal, which is marked L or coloured red.

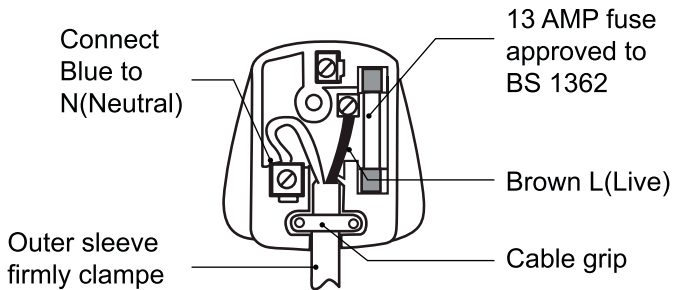

WARNING! Never connect live or neutral wires to the earth terminal of the plug, which is marked with E.

Only fit an approved 13 Amp BS 1363 or BS 1363/A plug and the correctly rated fuse. If in doubt, consult a qualified electrician.

If a moulded plug is fitted and has to be removed take great care in disposing of the plug and severed cable, it must be destroyed to prevent engaging into a socket.

Transportation



WARNING! Always carry the product by its main handle.
Never use the cord for carrying the product.

1. Switch the product off and disconnect it from the power supply.
2. Always carry the product by its rear handle.
3. Protect the product from any heavy impact or strong vibrations which may occur during transportation in vehicles.
4. Secure the product to prevent it from slipping or falling over.

Storage

1. Switch the product off and disconnect it from the power supply.
2. Clean the product as described above.
3. Store the product and its accessories in a dark, dry, frost-free, well-ventilated place.
4. Always store the product in a place that is inaccessible to children. The ideal storage temperature is between 10 °C and 30 °C.
5. We recommend using the original package for storage or covering the product with a suitable cloth or enclosure to protect it against dust.

Recycling and disposal



Waste electrical products should not be disposed of with household waste. Please recycle where facilities exist. Check with your local authority or local store for recycling advice.



Guarantee

At Erbauer we take special care to select high quality materials and use manufacturing techniques that allow us to create ranges of products incorporating design and durability. We carry out stringent testing procedures on all our tools and are confident that they can provide regular, sustained daily use during the period covered. That's why we offer a 2 year guarantee against manufacturing defects on our Erbauer power tool products.

This power tool is guaranteed for 2 years from the date of purchase, if bought in store, delivered or bought online. You may only make a claim under this guarantee upon presentation of your sales receipt or purchase invoice. Please keep your proof of purchase in a safe place.

This guarantee covers product failures and malfunctions provided the Erbauer power tool was used for the purpose for which it is intended and subject to installation, cleaning, care and maintenance in accordance with standard practice and with the information contained above and in the user manual. This guarantee does not cover defects and damage caused by or resulting from:

- Normal wear and tear
- Overload, misuse or neglect
- Repairs attempted by anyone other than an authorised agent
- Cosmetic damage
- Damage caused by foreign objects, substances or accidents
- Accidental damage or modification
- Failure to follow manufacturer's guidelines
- Loss of use of the goods

This guarantee is limited to parts recognised as defective. It does not, in any case, cover ancillary costs (movement, labour) and direct and indirect damage.

If the Erbauer power tool is defective during the guarantee period, then we reserve the right, at our discretion, to replace the item with a product of equivalent quality and functionality or to provide a refund.

This guarantee only applies to the country of purchase or delivery and is not transferrable to any other countries. This guarantee is non-transferrable to any other person or product. Relevant local law will apply to this guarantee.

Guarantee related queries should be addressed to a store affiliated with the distributor from where you purchased the Erbauer power tool.

This guarantee is in addition to and does not affect your statutory rights relating to faulty goods as a consumer.



Declaration of conformity



EU Declaration of Conformity

We
Kingfisher International Products Limited
3 Sheldon Square
London W2 6PX
United Kingdom

Declare that the product
 950W Belt sander
 EBS950

Serial number: from 000001 to 999999

Complies with the essential health and safety requirements of the following directives:
 2006/42/EC The Machinery Directive

References to the following harmonized standard were made:

EN 62841-1:2015
 EN 62841-2-4:2014

2014/30/EU Electromagnetic Compatibility directive
 References to the following harmonized standard were made:

EN 55014-1:2017
 EN 55014-2:2015
 EN 61000-3-2:2014
 EN 61000-3-3:2013

2011/65/EU, (EU) 2015/863 Restrictions of the Use of Certain Hazardous Substances in
 Electrical and Electronic Equipment

Authorised signatory and technical file holder:

Kingfisher International Products Limited
 3 Sheldon Square
 London W2 6PX
 United Kingdom

on: [01/10/2019]
 Eric Capotummino
 Group Quality Director



Declaration of conformity



EU Declaration of Conformity

We

Kingfisher International Products B.V.
 Rapenburgerstraat 175E 1011 VM Amsterdam
 The Netherlands

Declare that the product
 950W Belt sander
 EBS950
 Serial number: from 000001 to 999999

Complies with the essential health and safety requirements of the following directives:
 2006/42/EC The Machinery Directive

References to the following harmonized standard were made:
 EN 62841-1:2015
 EN 62841-2-4:2014

2014/30/EU Electromagnetic Compatibility directive
 References to the following harmonized standard were made:
 EN 55014-1:2017
 EN 55014-2:2015
 EN 61000-3-2:2014
 EN 61000-3-3:2013

2011/65/EU, (EU) 2015/863 Restrictions of the Use of Certain Hazardous Substances in
 Electrical and Electronic Equipment

Authorised signatory and technical file holder:
 Kingfisher International Products B.V.
 Rapenburgerstraat 175E 1011 VM Amsterdam
 The Netherlands

on: [01/10/2019]
 Eric Capotummino
 Group Quality Director

**Manufacturer • Fabricant • Producent •
Producator • Fabricante:**

Kingfisher International Products Limited,
3 Sheldon Square, London, W2 6PX,
United Kingdom
www.kingfisher.com/products

Kingfisher International Products B.V.
Rapenburgerstraat 175E 1011 VM Amsterdam
The Netherlands



Distributor:
www.diy.com
www.screwfix.com
www.screwfix.ie

To view instruction manuals online,
visit www.kingfisher.com/products
